

HD Operator

Hard-Working Heavy Duty Operators for Larger Spring-Balanced Roller Shutters

75004 (L/R)

Commercial Door Operators / Roller Shutter Operators / HD Operator

The HD portfolio is design for large spring-balanced roller shutters up to 80m². Fan-cooled motors and efficient gearboxes combine to offer a robust, durable and long serving operator. It is also available in various specialised models, such as with a solenoid brake, water-resistant or explosion proof.

Key Features

- Powerful 2.0Hp motor with purpose designed gearbox for durable, reliable operation
- Automatic chain-engage mechanism for safe and easy manual operation in the absence of power
- Ideal for larger spring-balanced roller shutters up to 80m²
- Choice of controls from Reversing Starters to the eDrive +2.0 Logic System for Mechanical Operators (GLMe2 portfolio)
- Rated for high duty cycle (30% run time)

What's in the Box?

HD Operator Only. All wall controls and mounting hardware available separately

Information for Roller Shutters

All operators have a recommended maximum Roller Shutter area listed in the specification table. All recommended sizes are based on a "Standard Roller Shutter" (refer below):

- The Shutter is correctly spring balanced
- The Shutter has max 1.0mm x min 100mm slats, with a Diameter 150mm drum for shutters max 36m², or Diameter 200mm drum for shutters 36 - 50m²
- The Shutter has no wind-locks
- A sprocket ratio $\geq 4:1$ is used



Product may differ slightly from image shown.

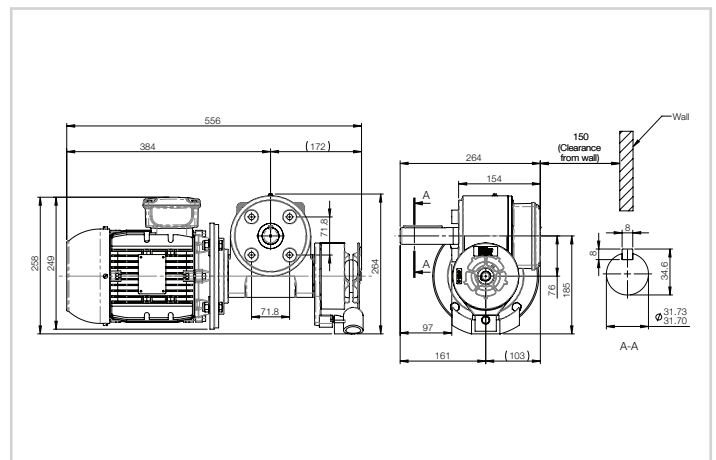

Product may differ slightly from image shown.

Model Details

Part No.	75004 (L/R)
Description	HD RSO H/C 2.0Hp 415V 3PH IP44

(L/R) indicates which side of the door opening the motor is mounted to (when viewed from inside the building). For example a model with an "L" suffix is mounted to the top left of the door opening.

Optional Controller Upgrade

Part No.	RG374-LB3E008
Description	Reversing Starter for basic Up / Stop / Down Control

Controller upgrade separately available. Please refer to the relevant Specification Sheet for details.

Specifications

kW	1.50kW	Phase	3ph	No Neutral (N)	N/A
Amps	3.30A	Max SB Door Size	80m ²	Pre-Wired (P)	N/A
Hp	2.0Hp	IP Rating	IP44	IP55 (W)	N/A
Voltage	415V	Duty Cycle	HC	Clutch (C)	N/A

LC = Low cycle (10% run time / hour).

HC = High cycle (30% run time / hour).

When specifying an upgraded model, please use the appropriate abbreviation before the "L" or "R" handing. For example 75004WR.

Upgrades:

O = Optional

S = Supplied as standard

N/A = Not applicable

Chamberlain Australia Pty Ltd

Head Office - Unit 1, 75 Epping Rd North Ryde NSW 2113
Manufacturing - 15 Dell Rd, West Gosford NSW 2250

Chamberlain New Zealand Ltd

17A Arrenway Dr, Rosedale 0632 Auckland NZ

AU: 1800 GRIFCO | www.grifco.com.au
NZ: 0800 653 667 | www.grifco.co.nz

Chamberlain Branches

Sydney - Unit 1, 75 Epping Rd North Ryde NSW 2113
Melbourne - Unit 18, 85-91 Keilor Park Dr Tullamarine VIC 3043
Brisbane - Unit 19, 140 Wecker Rd Mansfield QLD 4122
Perth - 54 Milrose Dr Malaga WA 6090